

Electrooptical Evaluation Techniques of Image Intensifier Tubes—Part II

I.J. Bhasin, N.K. Goyal, and V.K. Jain

Instruments Research & Development Establishment, Dehra Dun-248 001

ABSTRACT

In this paper, electrooptical evaluation techniques of image intensifier tubes for some of the important parameters like resolving power, absolute spectral responses of photocathode, spectral response of phosphor screen, modulation transfer function, recovery time, gas grade, and fixed-pattern noise have been described.

Keywords: Image intensifier tube, electrooptical evaluation techniques, night vision instruments, optical resolution, photocathode

1. INTRODUCTION

For evaluation of various types of image intensifier tubes (IITs), though MIL and DEF STAN specifications¹⁻⁵ have been made specifying the test conditions, yet details of test setups have not been highlighted. Besides, readymade test equipment for all the parameters are not available in the world market, hence, the users have to develop their own test facilities for testing various electrooptical parameters of image intensifier tubes. A complete range of such test facilities has been developed in this Laboratory.

2. RESOLVING POWER

In an electrooptical night vision instrument, the details in the final image are limited to the transfer characteristics of optical components (objective and eyepiece sub-assemblies) and the resolution capability of the image tube used in the system. The resolution of the optical parts has far better resolution capability than the image intensifier tube, as such, the ultimate

performance of a passive night vision device is mainly limited to the resolving power of the image intensifier tube. The resolving power of the image intensifier tube depends upon the particle size of the phosphor material, the transfer characteristics of the fibre optic components like face plate and microchannel plate, noise components of the electrons emitted, and distortion introduced due to electrostatic focusing (for ESI-type tubes). While, about 200 LP/mm resolution is fairly common for optical components, resolution of an image intensifier tube is about 30 LP/mm to 50 LP/mm for different types of image intensifier tubes.

The resolution of a system, which is expressed in LP/mm, is a measure of the ability of the system to separate out two near objects. The line or bar charts are normally used for measuring the limited resolution⁶⁻⁹ of an image intensifier tube. The limited resolution of the image intensifier tube is a measure of the smallest size of the pattern which can be just separated.

A novel method of measuring resolving power of an image intensifier tube has been evolved as shown in the Fig. 1 using a bar chart having 12

resolution patterns with different spacing as shown in the Fig. 2. A high contrast bar chart having 12 resolution patterns with different spacing is mounted

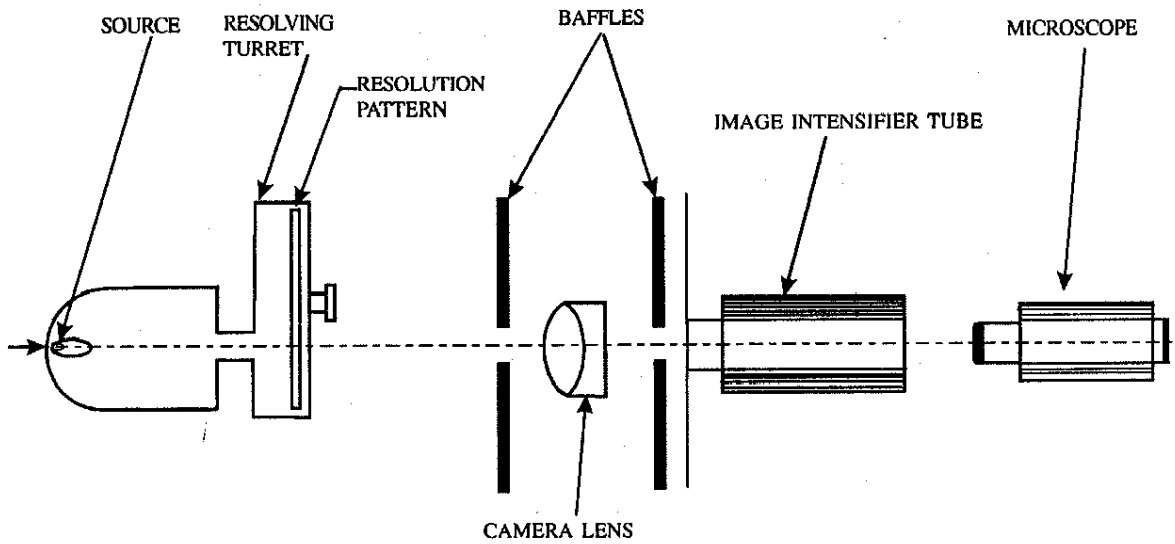

Figure 1. Measurement of resolving power of an image intensifier tube

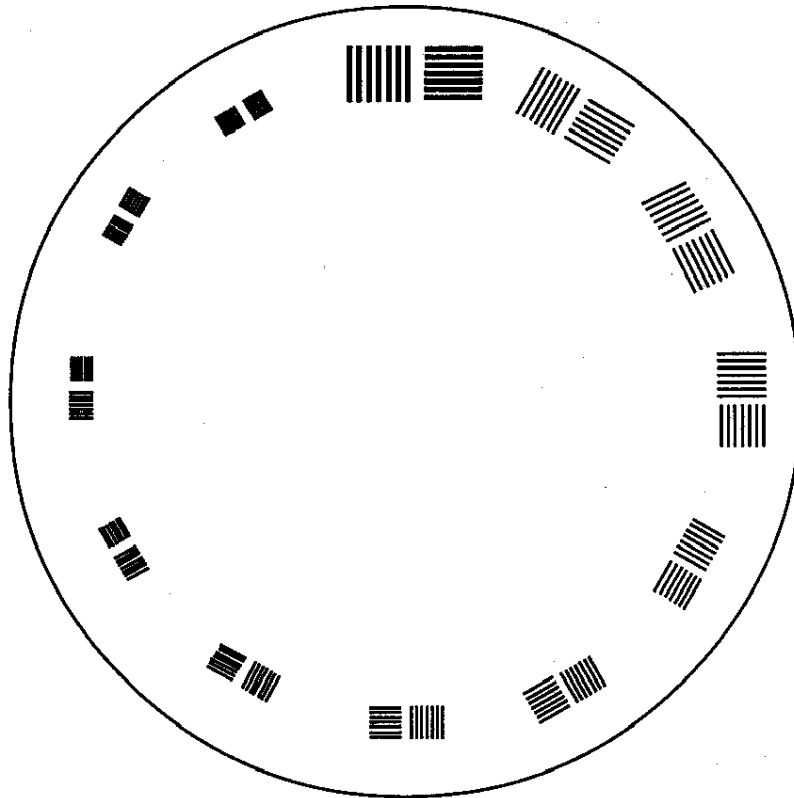

Figure 2. Resolution chart

on a rotatable turret. The chart can be rotated to project only one resolution pattern at a time on the photocathode of the image intensifier tube. The resolution patterns correspond to 34 LP/mm, 32 LP/mm, 30 LP/mm, 28 LP/mm, 26 LP/mm, 24 LP/mm, 22 LP/mm, 20 LP/mm, 18 LP/mm, 16 LP/mm, 14 LP/mm, and 12 LP/mm, respectively on the photocathode plane when demagnified 25 times using a well-corrected lens. The resolution chart is illuminated by the specified level and the screen image is viewed using a suitable microscope. Similarly, this pattern may be demagnified several times to evaluate higher resolution values of super generation and high definition image intensifier tubes.

3. PHOTOCATHODE SPECTRAL RESPONSE

Over the last couple of decades, S20, extended red S25, and GaAs response photocathodes⁶⁻⁸ have been developed for the image intensifier tubes. Typical spectral responses of these photocathodes are shown in the Fig. 3. As can be seen from the Fig. 4, starlight is sufficiently rich in the near-infrared region, besides visible part of illumination. In the recent years, efforts have been made to improve the photocathode sensitivities and high sensitive second-generation photocathodes have been developed, which when used in the image intensifier tubes, can gather more information from the night

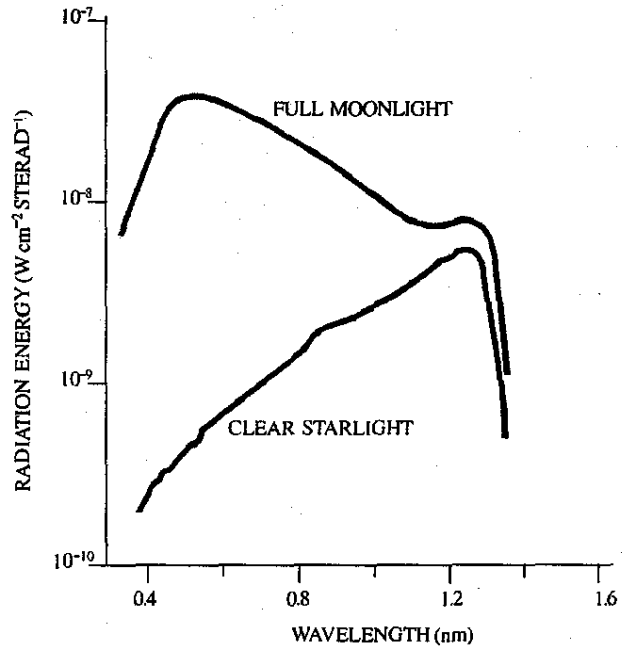

Figure 4. Starlight and moonlight characteristics

scene and provide about 20 per cent more detection range.

To verify the claims of the manufactures and the type of photocathode used in the image intensifier tubes, no specific test method has been mentioned in the international specifications, eg, MIL and DEF STAN specifications, and in the description, only the type of photocathode has been highlighted. It is, therefore, essential to specify a simple method to verify the claims of the manufacturers. A test procedure has been evolved for the evaluation of absolute spectral response of the photocathode. The layout of the test setup is shown in the Fig. 5.

The system mainly consists of an adjustable luminance source, an auto-ranging, flat-response EG&G radiometer/photometer, a Pritchard photometer 1980-A, and a set of interference filters. The luminance source is operated at a specific voltage and current is passed to get 2856K ± 50K colour temperature. The light from the luminance source falls on a beam splitter (uncoated glass plate) which splits the light into two parts. One part falls on photodetector of flat-response EG&G radiometer and the other part is allowed to fall on the photocathode of image intensifier tube. The interference filter of

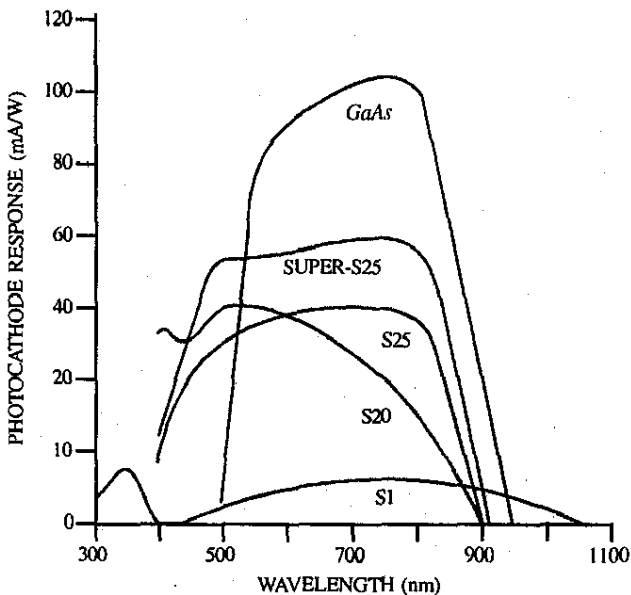

Figure 3. Comparison between the spectral sensitivities of S20, S25, super-S25, S1 and GaAs.

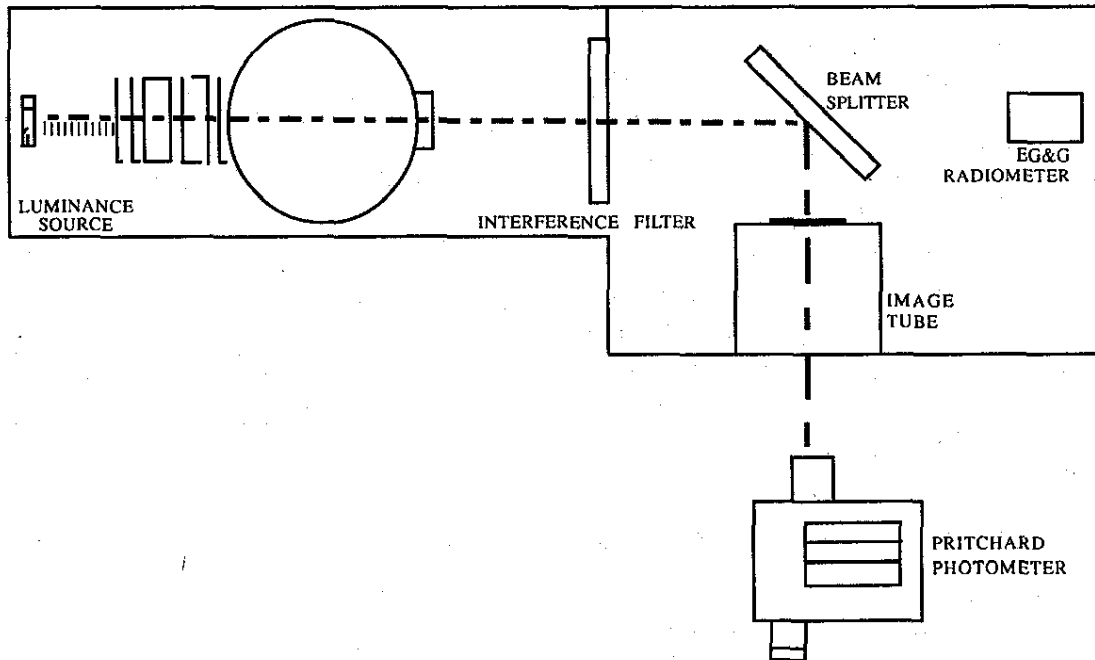

Figure 5. Setup for photocathode spectral response

420 nm is introduced in the path and the micrometer of luminance source is adjusted to get $1-3 \times 10^{-3} \mu\text{W}/\text{cm}^2$ input irradiance. The input irradiance falling at the photocathode gives the corresponding screen luminance, which is recorded by the Pritchard photometer 1980-A.

The interference filter of 420 nm is then replaced by another filter in the wavelength region of 440 nm to 900 nm at an interval of 10 nm or 20 nm. The input irradiance at the photocathode plane is adjusted for each wavelength by micrometer of luminance source to get constant-input irradiance at all the wavelengths and the corresponding screen luminance is recorded on control console of the Pritchard photometer.

By plotting the screen luminance values against wavelengths, one gets absolute spectral characteristics of photocathode of an image intensifier tube. A typical spectral response of photocathode based on the above measurements is shown in the Fig. 6. The test method developed is simple and can also be used to determine absolute spectral response of different types of photocathodes.

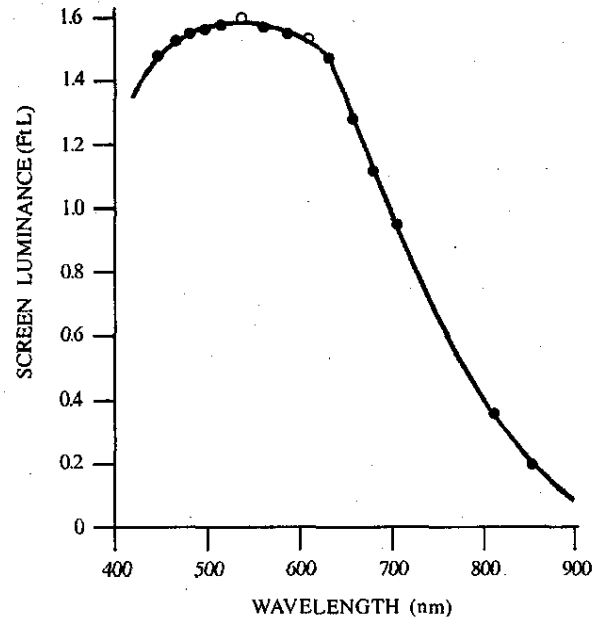

Figure 6. Spectral response of photocathode

4. PHOSPHOR SCREEN SPECTRAL RESPONSE

The spectral response of phosphor screen of an image intensifier tube is evaluated on a test setup as shown in the Fig. 7. The source (S) is

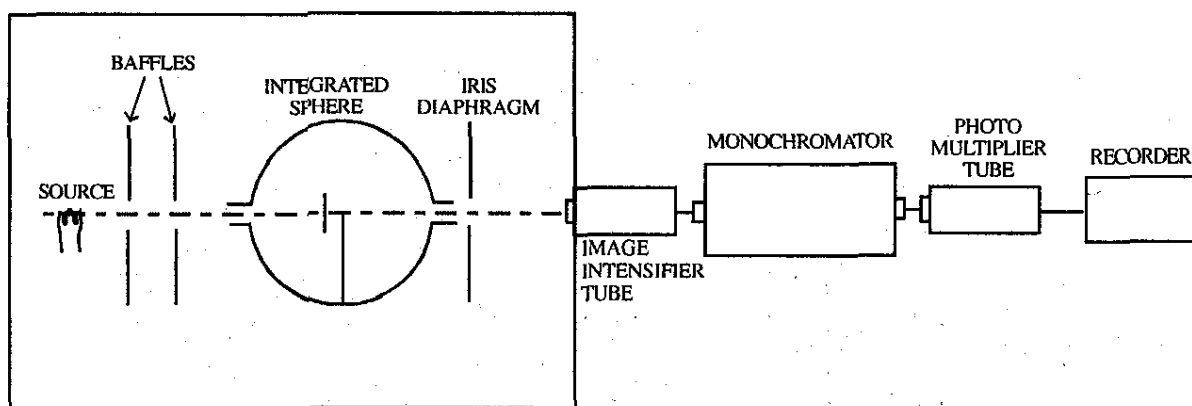

Figure 7. Evaluation of spectral response of phosphor screen of an image intensifier tube

operated at colour temperature $2856\text{K} \pm 50\text{K}$ by operating the tungsten-halogen lamp at the predetermined voltage and current. The radiation from the source is attenuated by adjusting the iris diaphragm and selecting the appropriate aperture in the low light level attenuator. The attenuated light is allowed to fall on the photocathode of an image intensifier tube and the light emitted by the phosphor screen of the image tube is analysed using a monochromator and a flat-response EG&G radiometer/photometer model 550-2B, and the detector output is recorded on the recorder. This gives the screen spectral response of the image intensifier tube.

5. MODULATION TRANSFER FUNCTION

The modulation transfer function of an image intensifier tube can be measured on a setup shown in the Fig. 8. A special nine-bar rectangular wave target simulating sine-wave response⁷ has been used to measure the modular transfer function at 2.5 LP/mm, 7.5 LP/mm, and 15.0 LP/mm frequency. The target is uniformly and incoherently illuminated by the Köhler illumination system. The objective lens of the device is used for imaging the target on the photocathode of the image intensifier tube. The illumination level at the photocathode is adjusted around $4 \times 10^{-4} \text{ lm/ft}^2$ to facilitate measurement in the linear region of the image intensifier tube. The image on the phosphor screen of the image intensifier tube is relayed on to a $5 \mu\text{m}$ wide scanning slit (attached to PM 200C photomultiplier

tube) by a well-corrected relay lens. The output of the photodetector is fed to an X-Y recorder. The image is scanned by controlled movement of the target to avoid phosphor persistence.

The image of the rectangular wave pattern can also be scanned using micro scanner spatial scanner model SC-80A with 20X lens coupled with a Pritchard photometer-1980-A or 1980-B fitted with $0.4 \times 10 \text{ min}$ slit aperture. The image contrast is calculated from the image irradiance trace on the recorder and the modulation transfer function of the image intensifier tube is computed as follows:

$$\text{Image contrast, } C = (I_{\text{max}} - I_{\text{min}}) / (I_{\text{max}} + I_{\text{min}})$$

The object contrast of the test target can be measured by the normal method. The ratio of the image contrast to the object contrast gives the modulation transfer function of the image intensifier tube under test at a particular frequency.

6. RECOVERY TIME

Passive night vision devices incorporating image intensifier tubes are normally used under low light levels of illumination. However, sometimes tubes are exposed to intense illumination due to firing/shell burst as prevalent under the battlefield conditions. The screen luminance of an image intensifier tube varies with the illumination falling on the photocathode. The screen luminance varies linearly from 10^{-5} lux to 10^{-2} lux and then it reaches a peak value known

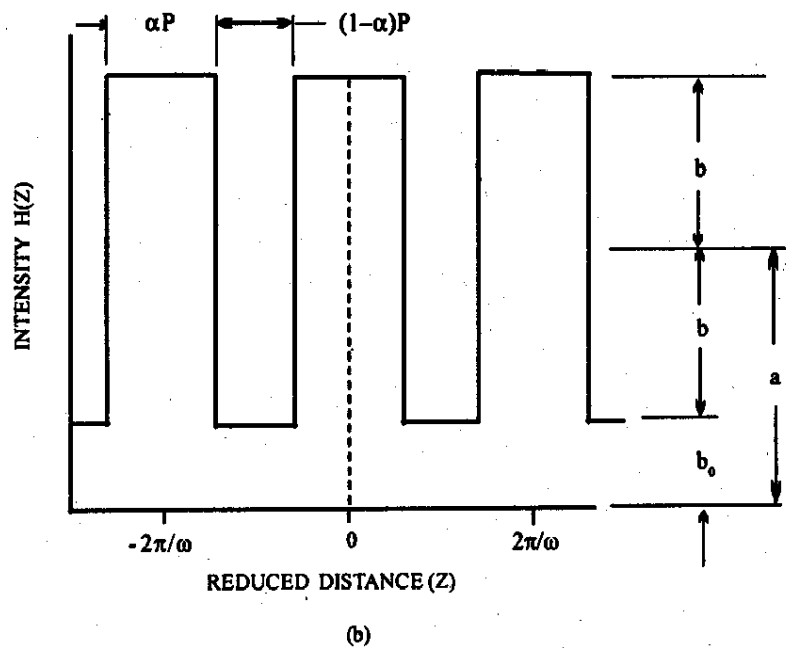
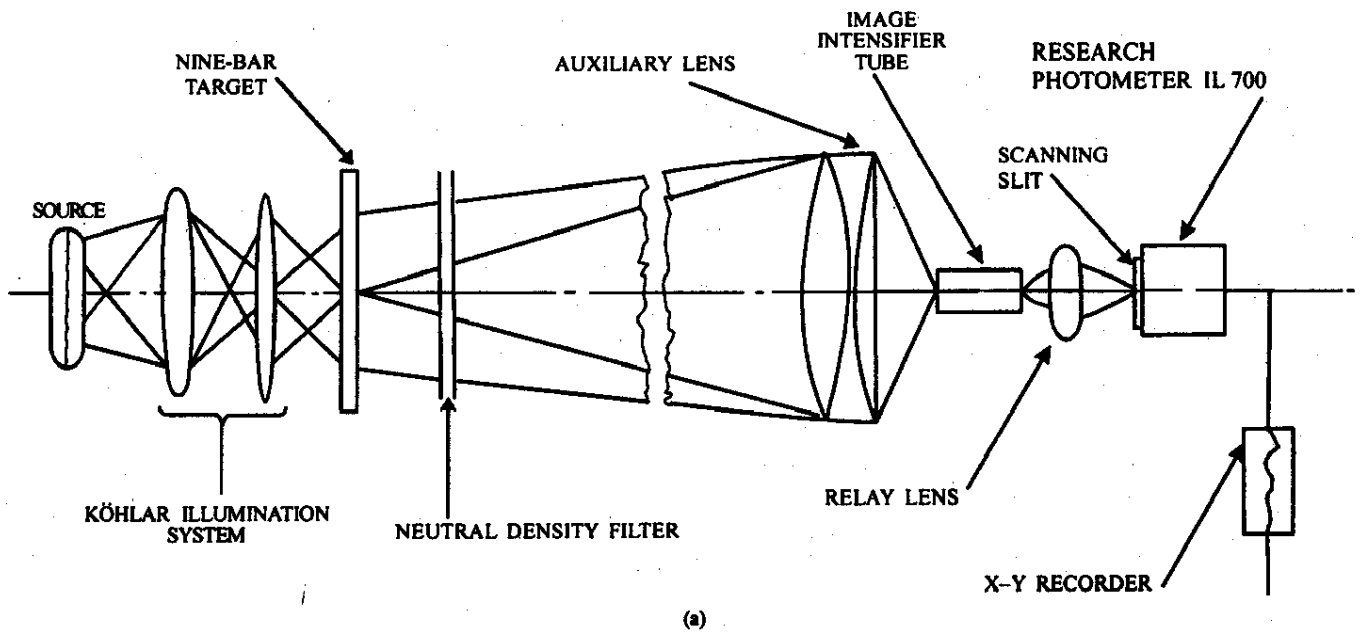

Figure 8. Setup for modulation transfer function of image intensifier tube

as maximum screen luminance, and if input illumination is increased further, the screen luminance falls rapidly due to automatic brightness control.

In the actual war condition, there are flares of light due to shell burst/some artificial source causing blanking off the passive night vision system, as the

image intensifier tube becomes automatically and instantaneously inoperative for a short period. It again recovers quickly to give a steady state screen luminance, which makes the target visible again in such conditions. The time gap between the switch off and the recovery of the optimum screen luminance should be the minimum possible. The recovery

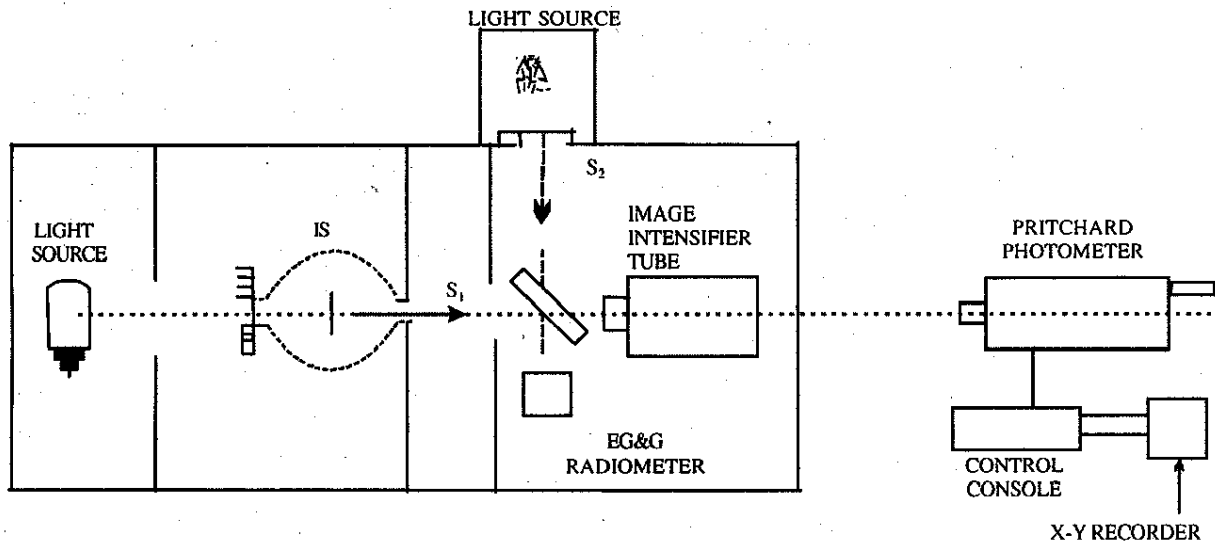

Figure 9. Test setup for recovery time of the image intensifier tubes

time is defined as the interval between the instant of increase of input illumination and the instant at which the screen luminance reaches an optimum value (eg, 5 cd/m^2 for the first-generation image intensifier tubes) following the blackout.

The response time of the image intensifier tube can be evaluated on the test setup shown in the Fig. 9. For this test, two sources are required, one source to produce $5 \times 10^{-3} \text{ lux}$ illumination and the other to produce 10 lux illumination at plane of photocathode (conditions of the first-generation image intensifier tubes). Similarly, conditions of the second-generation image intensifier tubes can also be adjusted in this setup. The colour temperature of both the sources are adjusted to $2856\text{K} \pm 50\text{K}$ by operating the sources at predetermined voltage and current.

The illumination levels of sources S_1 and S_2 can be measured using a calibrated photomultiplier tube like PM 200C fitted with cosine receptor coupled with IL 1700 research photometer and EG&G multi-probe 550-2B fitted with photopic filter, respectively. After giving exposures from sources S_1 and S_2 , the output screen luminance is recorded on an X-Y recorder coupled with the Pritchard photometer 1980-A. The response time characteristic, as shown in the Fig. 10, is obtained from which response time can be determined.

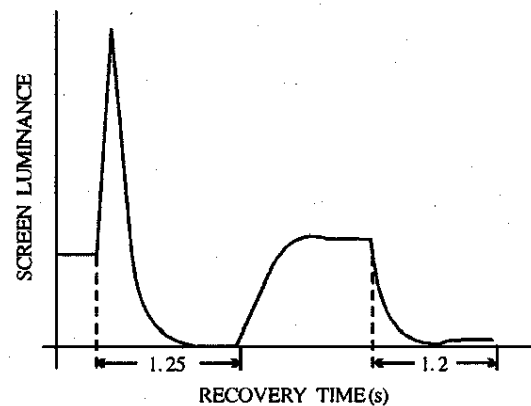
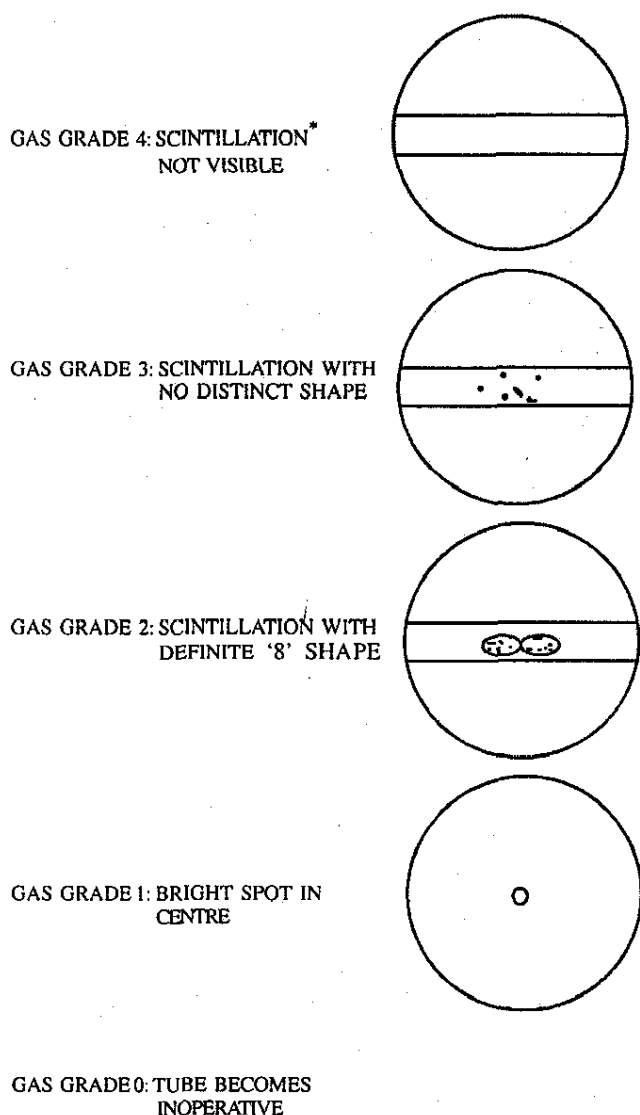

Figure 10. Recovery time of first-generation image intensifier tube.

The significance of the response time is that after the image intensifier tube becomes inoperative due to high intensity source to protect the eye of the observer as well as the image intensifier tube, it should not take much time to regain its normal functioning. The level of illumination is reduced to 5 m lux in 10 m/s , and again, time for the tube to attain 5 cd/m^2 is recorded.

7. GAS GRADE TEST

Gas grade test² is useful to assess the useful life of an image intensifier tube. Using this method, the expected life of an image intensifier tube can be assessed as it gives an idea of deterioration



* In actual practice, scintillation are white on yellowish-green background and are acceptable up to gas grade 3

Figure 11. Gas grades

of the image intensifier tube. A 12 mm black strip of nearly 100 per cent contrast is placed at the centre of photocathode of the image intensifier tube. The photocathode is exposed to 3×10^{-3} ft cd input illumination level. As in Fig. 11, scintillation with no distinct outline or shape (shown as gas grade 3) are acceptable. Beyond this, ie, gas grade 2, 1, or 0 are not acceptable as beyond gas grade 3, deterioration is very fast and the image intensifier tube needs replacement at this stage.

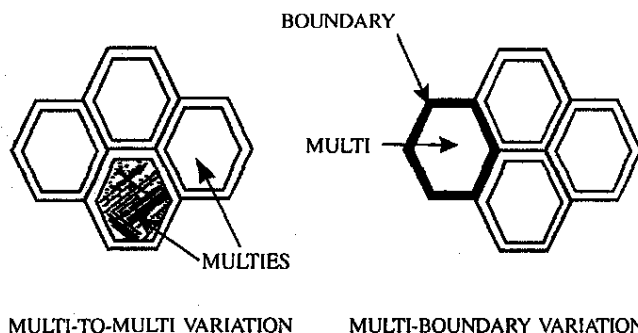

Figure 12. Multi-to-multi pattern variations caused by variations in brightness of different hexagonal-shaped bundles.

8. FIXED-PATTERN NOISE

This defect is caused by imperfection in the fibre-optic components used in the image intensifier tubes. There are mainly two types of fixed-pattern noise¹, namely multi-to-multi (M-M) pattern variation (also known as multi-gain variation) and multi-boundary pattern (M-B) variation. The multi-to-multi pattern variation is caused by variation in brightness of the different hexagonal-shaped bundles, as shown in Fig. 12. Sometimes, the dark bundles are more prominent than the light bundles or vice versa. This will create problem to the users as it may be clearly observed in field conditions.

The multi-boundary variation is caused by the variation in brightness in different multies and boundaries as shown in the Fig. 12. There are two types of multi-boundary noise. One is called dark multi-boundary noise or dark fixed-pattern noise. In this case, boundaries are darker than the rest of the bundles. The other type is known as light multi-boundary noise or light fixed-pattern noise. In this, boundaries are lighter than the rest of the bundles.

For evaluation of fixed-pattern noise, the voltage is applied to the image intensifier tube and the entire photocathode is illuminated by $1-5 \times 10^{-3}$ lux and $1-5 \times 10^{-2}$ lux, and the screen is observed with 10X eyepiece. If M-M pattern variation noise or M-B pattern variation noise are observed at the either light level, the quantitative measurement of luminance variation can be done using the Pritchard

photometer - 1980-A fitted with micro-cell MC-80-10X interchangeable lens. The observations are noted in the four affected multi-boundaries and their polarity and variations are calculated wrt the average brightness of the multies.

9. RESULTS & DISCUSSION

The resolving power test method using 12-bar resolution charts mounted on a rotatable turret is a novel method for the measurement of resolution of the image intensifier tubes. It has many advantages over USAF-1951 resolution chart. It gives reproducible

Table 1. Resolution power of the image intensifier tubes

First-generation IIT No.	Resolution power of IIT			
	Claimed (LP/mm)		Measured (LP/mm)	
7825-1140	31	31	32	30
5076	28	28	30	28
7625	28	32	30	32
76367	32	32	32	32
74603	32	30	32	32
74618	32	32	32	32
74750	29	28	28	27
74752	32	32	34	34
74854	32	28	30	28
74758	29	28	29	29

Table 2. Recovery time of the image intensifier tubes

First-generation IIT No.	Recovery time of IIT	
	Claimed (s)	Measured (s)
13053	0.88	0.90
13213	1.00	1.11
13273	0.96	1.00
55066	1.40	1.40
55335	0.50	0.60
13279	0.94	1.00
13514	0.86	0.80
13515	0.74	0.80
13525	1.08	1.10
13537	0.72	0.70

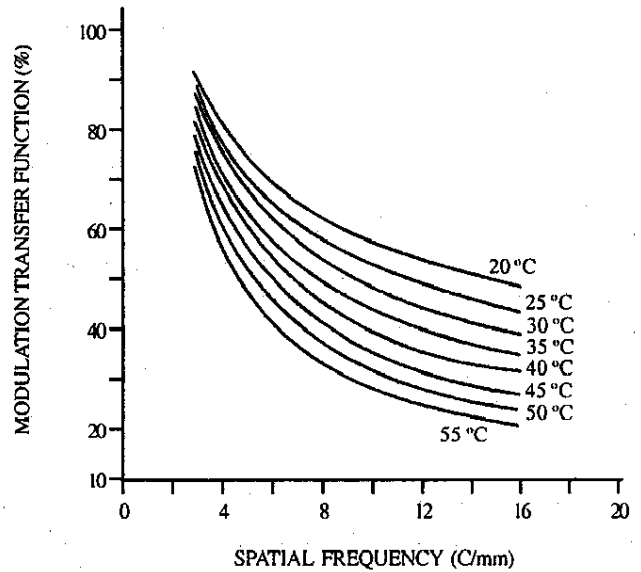

Figure 13. Variation of modular transfer function with spatial frequency.

and reliable observation because the observer is not biased, as he does not know the type of the pattern he is resolving. Further, resolution can be measured at an interval of 2 LP/mm in the region of interest with the help of suggested method, while USAF-1951 measures resolution at an interval of about 4-5 LP/mm. A few experimental results for resolution and recovery time are listed in Tables 1 and 2. This method is in regular use in the laboratory for the measurement of resolving power of first-generation, second-generation, and super generation image intensifier tubes. Besides resolution, the modular transfer function measurement is also essential as it defines overall performance of the second-generation image intensifier tubes. The experimental results at spatial frequencies from 2 LP/mm to 16 LP/mm and at different temperatures are given in Fig. 13.

The photocathode luminous and radiant sensitivities do not give sensitivities of second-generation tubes at all the wavelengths. Hence, it is essential to evaluate photocathode spectral response in the wavelength 400 nm to 900 nm. The method described here is simple and gives absolute photocathode spectral response of the image intensifier tube. The photocathode spectral response measured on this test setup is shown in the Fig. 6. This method can also be used to measure absolute spectral

response of photodetectors. The screen spectral response test method is also simple and can be easily rigged up in the laboratory.

In the actual battlefield conditions when shells bursts in the proximity of a soldier using passive night vision devices incorporating image intensifier tube, the tube becomes inoperative for a short period, blinding the soldier temporarily. The time taken to recover from the temporary blindness is the measure of recovery time of the image intensifier tube. Hence, it is very essential to evaluate this parameter.

The gas grade test is not given in MIL specification but it is an important parameter and should be measured as this test gives an idea of the useful life of an image intensifier tube. The fixed-pattern noise is another important parameter affecting the imagery. The various test setups described for all the measurements are very simple, inexpensive, and can easily be rigged up in the laboratory.

ACKNOWLEDGEMENTS

The authors are thankful to Shri J.A.R. Krishna Moorthy, Director, Instruments Research & Development Establishment (IRDE), Dehra Dun, for giving permission to publish this paper. Thanks are also due to Dr P.K. Dutta, Scientist, for giving valuable suggestions. The authors are also thankful to Shri Jagdish Prasad for rendering help in carrying out the experimental work.

REFERENCES

1. US Military specifications for image intensifier assembly-25 mm microchannel inverter MX-9644/UV. MIL-I-49040(EL), 1990.
2. US Military specifications for image intensifier assembly-18 mm micro channel wafer. MX-9916/UV, MIL-I-49052, 1980.
3. US Military specifications for image intensifier assembly-25 mm with ABC. MIL-I-55340, 1977.
4. UK Defence Specifications. Valve electronic, image intensifier tubes. DEF STAN 59-60/90/077, 1977.
5. UK Defence Specifications. Valve electronic, image intensifier tubes. DEF STAN 59-60/90/089, 1980.
6. Hall, J.A. Evaluation of direct-view imaging devices. *In* Photoelectronic imaging devices, Vol. 2: Devices and their evaluation, edited by Lucien M. Biberman and Sol Nudelman. Plenum Press, New York - London, 1971. pp. 53-76.
7. Hasegawa, S. Resolving power of image tubes. *In* Advances in electronics and electron physics, Vol. 28 B: Photoelectronic image devices, edited by J.D. McGee; D. McMullan; E. Kahan, and B.L. Morgan. Academic Press, New York, 1969. pp. 553-65.
8. Csorba, Illes P. Image tubes. *In* Howard W. Sams & Co Inc, USA, 1985. pp. 255-63.
9. Soule, Harold V. Electrooptical photography at low illumination level. *In* John Wiley & Sons Inc, USA, 1968. pp. 345-58.
10. Nijhawan, O.P.; Dutta, P.K. & Jagat Bhushan. On the measurement of MTF using periodic patterns of rectangular and triangular waveforms. *Nouv. Rev. Optique*, 1975, 6, 33.

Contributors



Mr I.J. Bhasin obtained his MSc (Physics) from the Lucknow University in 1963 and one-year advanced armament (instrumentation) training from the Institute of Armament Technology(IAT), Pune, during 1968-69. He joined DRDO in 1963 and worked at the DRL(M), Kanpur, now Defence Materials & Stores Research & Development Establishment, Kanpur, from 1964-68 and joined the Instruments Research & Development Establishment (IRDE), Dehra Dun, in 1969. His areas of research include: Optical, electrooptical, and fibre-optic instrumentation. He has developed a range of photometric and electrooptical test equipment and has setup a test laboratory for the evaluation of image intensifier tubes used in night vision devices. He is a member of the Optical Society of India.



Mr N.K. Goyal is a science graduate from the Agra University in 1962. He has been working at the IRDE, Dehra Dun, since 1963 towards the design and development of optical, electrooptical, and fibre-optic instrumentation. He is associated with the development of test setup for the evaluation of image intensifier tubes used in night vision devices. His areas of interest are: Photometry and fibre-optics. He is a member of the Optical Society of India.



Mr V.K. Jain is a science graduate from the Meerut University in 1972. He has been working at the IRDE, Dehra Dun, since 1968 towards the design and development of optical and electrooptical test instruments. He is associated with the development of test setup for the evaluation of image intensifier tubes used in night vision devices. His main area of research is photometry.